

<問題> さがしているものを下からみつけて、線でむすびましょう。

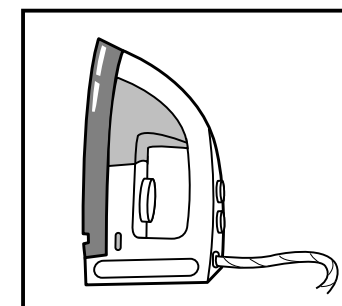
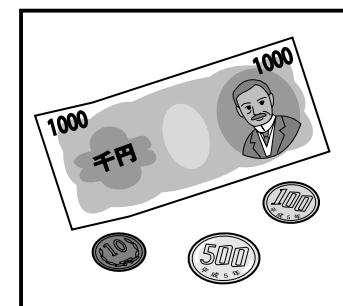
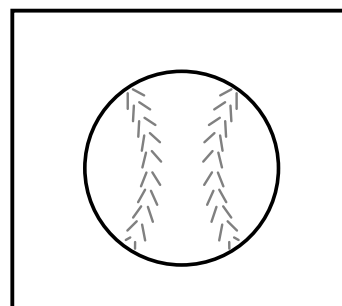
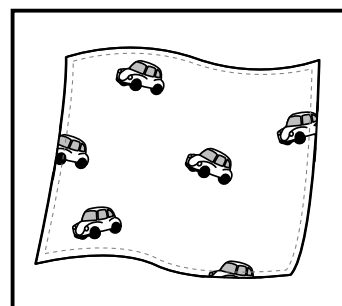
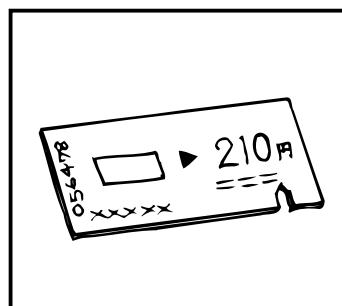
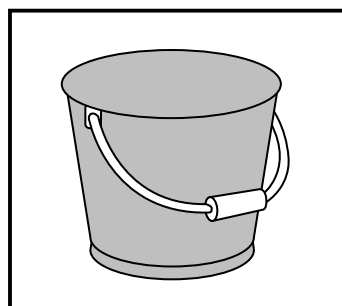
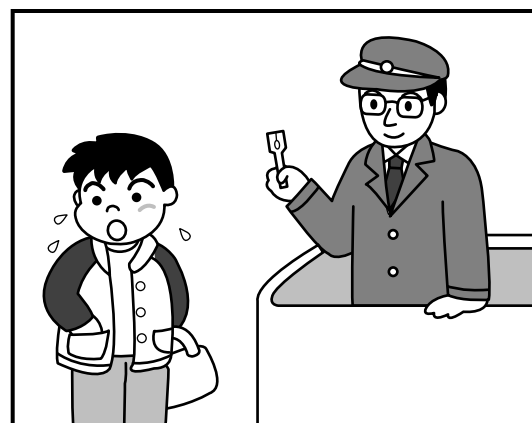
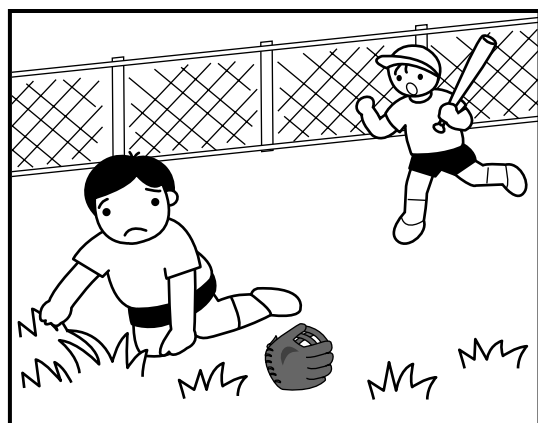

<指導のポイント>

絵を見ながら、「バットやグローブを持っている子がさがしているのは何でしょうか。」というように、説明しながら質問してあげてもよいでしょう。